 Electronic & Automation Systems	User Manual	Doc.Ref : JA-KNX-UM
	JA-KNX – Jablotron KNX Interface	Revision : 3.00
		Page : 1 of 18

ELAUSYS

JA-KNX

KNX Interface for Jablotron alarm system

User Manual



Document history			
Version.	Date	Author	Comment
1.00	24-JUN-2017	NDE	First issue
1.01	14-NOV-2017	NDE	Support for user codes of 4 digits without prefix
2.00	12-FEB-2018	NDE	Update firmware to standard Elausys "Alarm System Gateway V2.00" ETS Application
3.00	02-AUG-2021	NDE	Changed hardware layout and added optional DIN-rail housing



	User Manual	Doc.Ref : JA-KNX-UM
	JA-KNX – Jablotron KNX Interface	Revision : 3.00
		Page : 2 of 18

TABLE OF CONTENT

1. INTRODUCTION	3
2. OVERVIEW	4
2.1USAGE & LIMITATION	4
2.1SOFTWARE	5
2.2CONNECTION DIAGRAM	5
3. PARAMETERS	6
3.1GENERAL SETTINGS	6
3.2PG	8
3.3ZONE	9
3.4AREA.....	9
4. COMMUNICATION OBJECTS	10
4.1GENERAL	10
4.2PG	10
4.3AREA.....	11
4.4GROUP OBJECT LIST.....	12
5. CONFIGURATION	14
5.1PHYSICAL DEVICE	14
5.2PARAMETERS	14
5.1GROUP OBJECTS.....	16
6. FIRMWARE VERSION	17
7. TROUBLESHOOTING	17
8. DATASHEET	18

	User Manual	Doc.Ref : JA-KNX-UM
	JA-KNX – Jablotron KNX Interface	Revision : 3.00
		Page : 3 of 18

1. INTRODUCTION

The KNX interface module JA-KNX is a KNX gateway for the Jablotron 100 alarm systems. It enables bidirectional communication with the alarm system using the RS485 communication module (JA-121T) from Jablotron.

It allows integrators to take advantage of a fully integrated alarm system including KNX scenarios, automatic lighting using the motion detectors, arming or monitoring the system using a KNX visualization.

Main features:

- KNX Interface for Jablotron 100 alarm systems
- Up to **32 bidirectional input/output (PG)**
- **Status of each zone** in real time
- Control up to **4 areas** (arm/partial/disarm)
- 9 status per area (intrusion, entry, exit, fire,...)
- Recall of KNX **scenes** for each status
- Built-in termination resistor for RS485
- Communication fault monitoring
- Galvanic insulation from the KNX bus
- RX/TX communication status LED
- **Optional DIN-Rail housing**

	User Manual	Doc.Ref : JA-KNX-UM
	JA-KNX – Jablotron KNX Interface	Revision : 3.00
		Page : 4 of 18

2. OVERVIEW

2.1 USAGE & LIMITATION

This interface is intended to be used with a JABLOTRON 100 series alarm system. The system must be equipped with a JA121T module for RS485 communication.

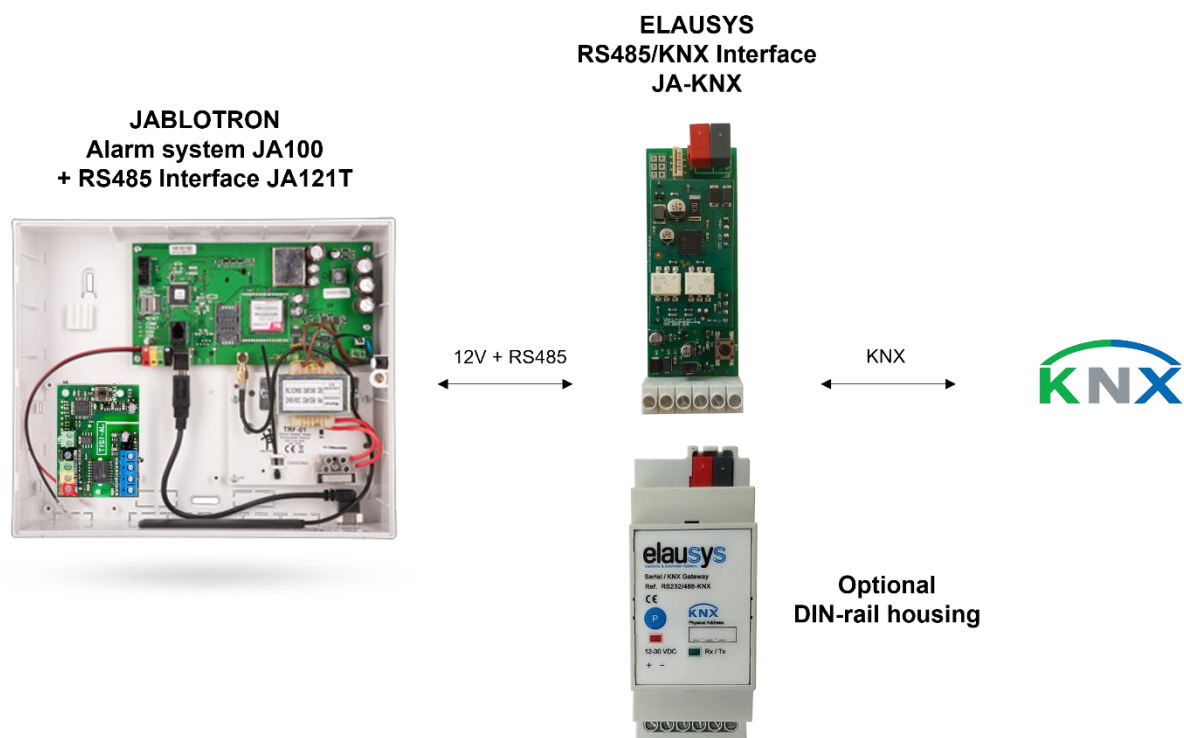

The gateway can be mounted directly inside the alarm system panel or on an external DIN-rail using the optional housing.

NOTE: When a user is logged in service mode on the alarm system, the RS485 and KNX interface are disabled.

	User Manual	Doc.Ref : JA-KNX-UM
	JA-KNX – Jablotron KNX Interface	Revision : 3.00
		Page : 5 of 18

2.1 SOFTWARE

The KNX Interface is configured using the ETS tool, the free ETS Demo version can be [downloaded](#) from the website of KNX Association. The free version allows to configure up to 5 KNX modules in a project, the KNX gateway is only one module, all devices can be configured using this version.

2.2 CONNECTION DIAGRAM

Elausys JA-KNX is galvanically isolated from the KNX bus, therefore the 12VDC power supply should be provided by an external power supply or from the alarm system itself, to the J121T module output and to the JA-KNX gateway.

The RS485 bus must be interconnected between the JA121T and the JA-KNX interface. The RS485 termination resistor is already integrated on the KNX interface module, therefore no additional component or wiring is required. The JA121T module must be configured at 9600 baud.

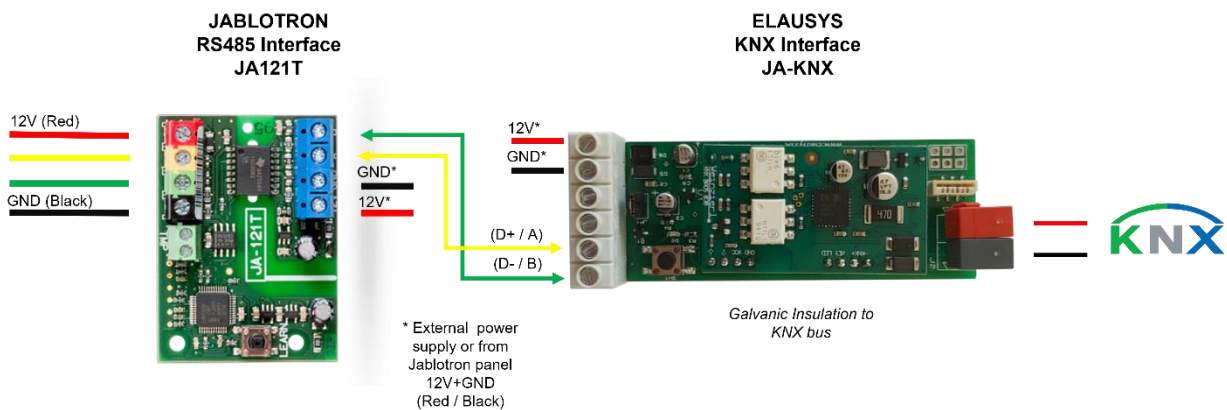

Terminal block connection:

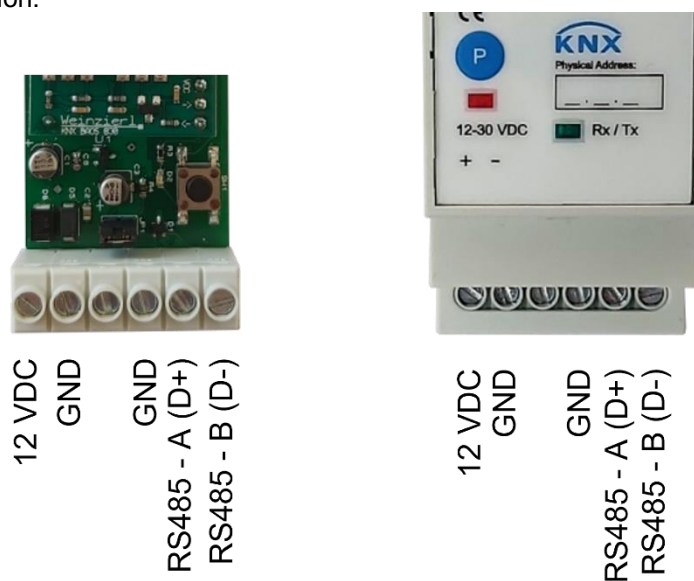

	User Manual	Doc.Ref : JA-KNX-UM
	JA-KNX – Jablotron KNX Interface	Revision : 3.00
		Page : 6 of 18

3. PARAMETERS

The KNX interface parameters are defined in the “parameters” tab of the device, in the ETS project.

3.1 GENERAL SETTINGS

The following parameters are defined in the General section of the device parameters:

PARAMETER	VALUES	DESCRIPTION
Use PG Control	<ul style="list-style-type: none"> ▪ Not used (default) ▪ Used 	When this parameter is set to “Used”, the PG control group objects are made available.
Use PG Status	<ul style="list-style-type: none"> ▪ Not used (default) ▪ Used 	When this parameter is set to “Used”, the PG status group objects are made available.
Number of PG	<ul style="list-style-type: none"> ▪ 16 (default) ▪ 32 	Number of PG control and status group objects to be used
Use Zone Status	<ul style="list-style-type: none"> ▪ Not used ▪ Used (default) 	When this parameter is set to “Used”, the zone status group objects are made available.
Number of zones	<ul style="list-style-type: none"> ▪ 16 (default) ▪ 32 ▪ 48 ▪ 64 ▪ 72 ▪ 96 	Number of zone status group objects to be used.
Zones offset	<ul style="list-style-type: none"> ▪ 0 (default) ▪ 96 	An offset of 0 will use zones 1 to 96 from the alarm system whereas an offset of 96 will use zones 97 to 192

	User Manual	Doc.Ref : JA-KNX-UM
	JA-KNX – Jablotron KNX Interface	Revision : 3.00
		Page : 7 of 18

Use Virtual inputs	<ul style="list-style-type: none"> ▪ Not used (default) ▪ Used 	This parameter must be set to "Not used" for the Jablotron interface. Virtual inputs are not available on this device.
Number of areas	<ul style="list-style-type: none"> ▪ 1 (default) ▪ 2 ▪ 3 ▪ 4 	Number of areas to control/monitor from the KNX interface
Send area status	<ul style="list-style-type: none"> ▪ ON ▪ OFF ▪ ON/OFF (default) 	Area status object can be configured to send only the changes to ON values, only the changes to OFF values or both ON and OFF values
User code	Text field (format 1*1234)	When using control commands from KNX, a valid user code of up to 6 digits is required. This applies to area control (arm, disarm,...)
User code lenght	4..6	Number of digits for the user code
Use Power supply status	<ul style="list-style-type: none"> ▪ Not used (default) ▪ Used 	This parameter must be set to "Not used" for the Jablotron interface. Power supply status is not available on this device.
PG and Zone startup behavior	<ul style="list-style-type: none"> ▪ Switch OFF (default) ▪ Switch ON ▪ Memory 	Internal status of group object after restart. Memory will restore the state of group objects before power lost.
Device Options	Text string	Device options are not available on this device.

	User Manual	Doc.Ref : JA-KNX-UM
	JA-KNX – Jablotron KNX Interface	Revision : 3.00
		Page : 8 of 18

3.2 PG

PG Control and PG Status must be enabled in the general parameters to enable the corresponding group objects. Depending on the general parameter “Number of PG”, 16 or 32 PGs are listed in the group objects. Jablotron alarm system uses a maximum of 32 PGs.

The status of each PG from the Jablotron alarm system can be monitored by a Group object. The PG can be configured in the Jablotron system to send status based on specific events. Each PG of the Jablotron alarm system can also be controlled from KNX by a Group object.

	User Manual	Doc.Ref : JA-KNX-UM
	JA-KNX – Jablotron KNX Interface	Revision : 3.00
		Page : 9 of 18

3.3 ZONE

Depending the general parameter “Number of zones”, up to 96 zones are listed in the group objects.

The status of each zone from the Jablotron alarm system can be monitored by a Group object.

The general parameter “Zones offset” allow to use zones 1 to 96 from the alarm system or zones 97 to 192.

3.4 AREA

Depending the general parameter “Number of areas”, up to 4 areas are listed in the group objects.

Each area can be controlled by using the 3 group objects: Arm, partial arm or disarm. Several statuses are available and have a dedicated group object.

CONTROL OBJECT	VALUE ON	VALUE OFF
Arm (switch)	Arm	Disarm
Partial arm (switch)	Partial Arm	Disarm
Disarm (trigger)	Disarm	Disarm

For each area, a tab is made visible to configure the area parameters.

Areas are configured for areas 1 to 4 of the alarm system but by changing the parameter “Area mapping” it is also possible to cover the areas 5 to 8.

A scene can be assigned to each status. This scene number will be recalled each time the zone status is active (ON).

Leave the scene number to 0 to disable the scene control.

STATE	SCENE
Disarmed	0..64
Entry	0..64
Exit	0..64
Armed	0..64
Partial armed	0..64
Fire alarm	0..64
Siren ON (Audible alarm)	0..64
Panic alarm (Silent alarm)	0..64
Intrusion alarm	0..64

	User Manual	Doc.Ref : JA-KNX-UM
	JA-KNX – Jablotron KNX Interface	Revision : 3.00
		Page : 10 of 18

4. COMMUNICATION OBJECTS

4.1 GENERAL

General communication objects of the device.

GO	NAME	DESCRIPTION
1	Module status	Sends 0 when the module is operating normally, sends an error code when applicable.
2	Firmware	Sends the firmware version of the device at s
233	Call scene	The scene number configured for each area status are sent to KNX whenever the area status is activated

4.2 PG

Each PG has 2 Group Objects (GO), one for PG control from KNX and one for PG status to KNX.

GO	NAME	DESCRIPTION
1	PGx	PG Control from KNX
2	PGx Status	PG status

This chapter details what GO are available for each PG. The same GO applies to all other PG (x = 1 to 32).

4.3 AREA

Each area has 12 Group Objects (GO), 3 for area control and 9 for the area status to KNX.

GO	NAME	DESCRIPTION
185	Area x - Arm	Arm the Area
186	Area x – Stay arm	Stay arm the Area
187	Area x – Disarm	Disarm the Area
188	Area x – State disarmed	Area x status
189	Area x – Entry delay	Area x status
190	Area x – Exit delay	Area x status
191	Area x – State armed	Area x status
192	Area x – State partial armed	Area x status
193	Area x – Fire alarm	Area x status
194	Area x – Siren ON	Area x status
195	Area x – Panic alarm	Area x status
196	Area x – Intrusion alarm	Area x status

This chapter details what GO are available for each AREA. The same GO applies to all other areas (x = 1 to 4).

	User Manual	Doc.Ref : JA-KNX-UM
	JA-KNX – Jablotron KNX Interface	Revision : 3.00
		Page : 12 of 18

4.4 GROUP OBJECT LIST

GO	Name	Function	Size	Flags	Type ID	Type Name	Range	Description
1	Module status	Status code	1 byte	C R - T -	20.011	DPT_ErrorClass_System		Device error code
2	Firmware	Text string	14 bytes	C R - T -	16.000	DPT_String_ASCII		Device firmware version
3	PG1	On/Off	1 bit	C - W - -	1.001	DPT_Switch	0..1	PG – On/Off
4	PG1 Status	On/Off	1 bit	C R - T -	1.001	DPT_Switch	0..1	PG – On/Off status
5	PG2	On/Off	1 bit	C - W - -	1.001	DPT_Switch	0..1	PG – On/Off
6	PG2 Status	On/Off	1 bit	C R - T -	1.001	DPT_Switch	0..1	PG – On/Off status
...	<i>Same for PG3 to PG31</i>							
64	PG32	On/Off	1 bit	C - W - -	1.001	DPT_Switch	0..1	PG – On/Off
66	PG32 Status	On/Off	1 bit	C R - T -	1.001	DPT_Switch	0..1	PG – On/Off status
67	Zone 1 Status	On/Off	1 bit	C R - T -	1.001	DPT_Switch	0..1	Zone – On/Off status
68	Zone 2 Status	On/Off	1 bit	C R - T -	1.001	DPT_Switch	0..1	Zone – On/Off status
...	<i>Same for Zone 3 to 95</i>							
162	Zone 96 Status	On/Off	1 bit	C R - T -	1.001	DPT_Switch	0..1	Zone – On/Off status
163	AC Failure	On/Off	1 bit	C R - T -	1.001	DPT_Switch	0..1	On/Off status (NOT USED)
164	Battery Failure	On/Off	1 bit	C R - T -	1.001	DPT_Switch	0..1	On/Off status (NOT USED)
169	Virtual input 1	Open/Close	1 bit	C - W - -	1.001	DPT_Switch	0..1	Open/close input (NOT USED)
170	Virtual input 2	Open/Close	1 bit	C - W - -	1.001	DPT_Switch	0..1	Open/close input (NOT USED)
...	<i>Same for input 3 to 15</i>							

	User Manual	Doc.Ref : JA-KNX-UM
	JA-KNX – Jablotron KNX Interface	Revision : 3.00
		Page : 13 of 18

GO	Name	Function	Size	Flags	Type ID	Type Name	Range	Description
184	Virtual input 16	Open/Close	1 bit	C - W - -	1.001	DPT_Switch	0..1	Open/close input (NOT USED)
185	Area 1 - Arm	On/Off	1 bit	C - W - -	1.017	DPT_Switch	0..1	Arm Area
186	Area 1 – Partial arm	On/Off	1 bit	C - W - -	1.017	DPT_Switch	0..1	Partial arm Area
187	Area 1 – Disarm	On	1 bit	C - W - -	1.017	DPT_Trigger	0..1	Disarm Area
188	Area 1 – state disarmed	On/Off	1 bit	C R - T -	1.001	DPT_Switch	0..1	Area state disarmed
189	Area 1 – entry delay	On/Off	1 bit	C R - T -	1.001	DPT_Switch	0..1	Area entry delay status
190	Area 1 – exit delay	On/Off	1 bit	C R - T -	1.001	DPT_Switch	0..1	Area exit delay status
191	Area 1 – state armed	On/Off	1 bit	C R - T -	1.001	DPT_Switch	0..1	Area state armed status
192	Area 1 – state partial armed	On/Off	1 bit	C R - T -	1.001	DPT_Switch	0..1	Area state partial armed status
193	Area 1 – Fire alarm	On/Off	1 bit	C R - T -	1.001	DPT_Switch	0..1	Area fire alarm
194	Area 1 – Siren ON	On/Off	1 bit	C R - T -	1.001	DPT_Switch	0..1	Area siren ON
195	Area 1 – Panic alarm	On/Off	1 bit	C R - T -	1.001	DPT_Switch	0..1	Area panic alarm
196	Area 1 – Intrusion alarm	On/Off	1 bit	C R - T -	1.001	DPT_Switch	0..1	Area intrusion alarm
...	<i>Same for AREA 2 to 4</i>							
233	Call scene	-	1 Byte	C - - T -	18.001	DPT_SceneControl	1..64	Scene control

	User Manual	Doc.Ref : JA-KNX-UM
	JA-KNX – Jablotron KNX Interface	Revision : 3.00
		Page : 14 of 18

5. CONFIGURATION

5.1 PHYSICAL DEVICE

ELAUSYS devices are configured using the ETS tool. You should first download and install the free version of ETS tool before you continue.

The JA-KNX Interface must be assigned a physical address on the KNX network. Assign a free address to the module, in our example we choose 1.1.30.



5.2 PARAMETERS

Once a KNX physical address is set, open the parameter tab to configure the interface. The parameters are grouped into sections: A general section and a section for each area configured.

1.1.50 ELAUSYS EVO-KNX > General

<p>General</p> <ul style="list-style-type: none"> Area 1 Area 2 Area 3 Area 4 	<p>PG</p> <p>Use PG Control : <input checked="" type="radio"/> Not used <input type="radio"/> Used</p> <p>Use PG Status : <input type="radio"/> Not used <input checked="" type="radio"/> Used</p> <p>Number of PG : <input type="radio"/> 16 <input checked="" type="radio"/> 32</p> <p>Zones</p> <p>Use Zone Status : <input type="radio"/> Not used <input checked="" type="radio"/> Used</p> <p>Number of zones : <input type="text" value="96"/></p> <p>Zones Offset : <input checked="" type="radio"/> 0 <input type="radio"/> 96</p> <p>Use Virtual Inputs : <input type="radio"/> Not used <input checked="" type="radio"/> Used</p> <p>Areas</p> <p>Number of Areas : <input type="text" value="4"/></p> <p>Send Area Status : <input type="text" value="ON/OFF"/></p> <p>General</p> <p>User code : <input type="text" value="123456"/></p> <p>User code lenght : <input type="text" value="6"/></p> <p>Use Power Supply Status : <input type="radio"/> Not used <input checked="" type="radio"/> Used</p> <p>PG and Zone startup behavior : <input type="text" value="Switch OFF"/></p> <p>Device options : <input type="text"/></p>
--	---

In the general section, enter a valid user code from the alarm system to enable area control.

Enable the required group objects and select the number of PG, zone and areas to be used. For each Area selected, a tab is available in the left side menu to configure the scene control.

Open the first Area parameters by selecting the section “Area 1”.

By default, Area 1 is mapped to area 1 of the alarm system, by changing this value to 5 for example, Area 1 of the KNX interface would be linked to area 5 in the alarm system.

For each status of the Area, set the scene number to be called. Leaving the scene number to 0 will disable it.

1.1.50 ELAUSYS EVO-KNX > Area 1

General	Area mapping :	1
Area 1	Call scene when :	
Area 2	Disarm :	1
Area 3	Entry :	2
Area 4	Exit :	3
	Arm :	4
	Partial armed :	5
	Fire alarm :	6
	Siren ON :	7
	Panic alarm :	8
	Intrusion Alarm :	9

Then repeat the same process for each Area in your project.

	User Manual	Doc.Ref : JA-KNX-UM
	JA-KNX – Jablotron KNX Interface	Revision : 3.00
		Page : 16 of 18

5.1 GROUP OBJECTS

A group address (GA) must be assigned to each group object (GO) needed by the application. Open the Group Objects tab of the device and assign a GA to the object scene, PGs, zones, and areas as needed.

4	PG 1 Status	On/Off	PG	1/1/1	1 bit	C	R	-	T	-	switch	Low
6	PG 2 Status	On/Off	PG	1/1/2	1 bit	C	R	-	T	-	switch	Low
8	PG 3 Status	On/Off			1 bit	C	R	-	T	-	switch	Low
10	PG 4 Status	On/Off			1 bit	C	R	-	T	-	switch	Low
12	PG 5 Status	On/Off			1 bit	C	R	-	T	-	switch	Low
14	PG 6 Status	On/Off			1 bit	C	R	-	T	-	switch	Low
16	PG 7 Status	On/Off			1 bit	C	R	-	T	-	switch	Low
18	PG 8 Status	On/Off			1 bit	C	R	-	T	-	switch	Low
20	PG 9 Status	On/Off			1 bit	C	R	-	T	-	switch	Low
22	PG 10 Status	On/Off			1 bit	C	R	-	T	-	switch	Low
24	PG 11 Status	On/Off			1 bit	C	R	-	T	-	switch	Low
26	PG 12 Status	On/Off			1 bit	C	R	-	T	-	switch	Low
28	PG 13 Status	On/Off			1 bit	C	R	-	T	-	switch	Low
30	PG 14 Status	On/Off			1 bit	C	R	-	T	-	switch	Low
32	PG 15 Status	On/Off			1 bit	C	R	-	T	-	switch	Low
34	PG 16 Status	On/Off			1 bit	C	R	-	T	-	switch	Low

Example for Area 1:

Number	Name	Object Function	Description	Group Address	Length	C	R	W	T	U	Data Type	Priority
185	Area 1 - Arm	On/Off	Arm	2/1/1	1 bit	C	-	W	-	-	switch	Low
186	Area 1 - Partial Arm	On/Off	Partial Arm	2/1/2	1 bit	C	-	W	-	-	switch	Low
187	Area 1 - Disarm	On	Disarm	2/1/3	1 bit	C	-	W	-	-	trigger	Low
188	Area 1 - Disarmed	On/Off	State disarmed	2/1/13	1 bit	C	R	-	T	-	switch	Low
189	Area 1 - Entry delay	On/Off	Entry	2/1/9	1 bit	C	R	-	T	-	switch	Low
190	Area 1 - Exit delay	On/Off	Exit	2/1/10	1 bit	C	R	-	T	-	switch	Low
191	Area 1 - Armed	On/Off	State armed	2/1/12	1 bit	C	R	-	T	-	switch	Low
192	Area 1 - Partial Armed	On/Off	State armed parti...	2/1/11	1 bit	C	R	-	T	-	switch	Low
193	Area 1 - Fire Alarm	On/Off	Fire	2/1/5	1 bit	C	R	-	T	-	switch	Low
194	Area 1 - Siren ON	On/Off	Audible alarm	2/1/14	1 bit	C	R	-	T	-	switch	Low
195	Area 1 - Panic Alarm	On/Off	Panic Alarm	2/1/0	1 bit	C	R	-	T	-	switch	Low
196	Area 1 - Intrusion Alarm	On/Off	Intrusion alarm	2/1/4	1 bit	C	R	-	T	-	switch	Low

When GO and parameters are all configured, download the KNX Interface application to the device. The first download requires to press the programming button on the device to set the device in KNX programming mode then perform a full download.

	User Manual	Doc.Ref : JA-KNX-UM
	JA-KNX – Jablotron KNX Interface	Revision : 3.00
		Page : 17 of 18

6. FIRMWARE VERSION

This user manual and related ETS application is valid for firmware versions V2.00 and above.

A “Firmware” group object is available on the device to read the firmware version as a string. It is also automatically sent at power up.

Number	Name	Object Function	Description	Group Address	Length	C	R	W	T	U	Data Type	Priority
1	Module status	Status code	ModuleStatus	0/0/1	1 byte	C	R	-	T	-	system error class	Low
2	Firmware version	Text string	Firmware	0/0/4	14 bytes	C	R	-	T	-	Character String (AS...	Low

7. TROUBLESHOOTING

In case of troubles to establish the communication, the JA-KNX gateway has a RX/TX LED that indicates the status of the RS485 communication. The LED blinks each time a telegram is sent or received by the gateway.

If the LED blink but no telegram is received on the KNX side, verify that the ETS application program is loaded in the JA-KNX gateway and that group addresses are assigned to the required objects. Download the application program and read the firmware version of the JA-KNX module using the dedicated object. A string should be returned indicating the firmware version “JA-KNX Rx.xx”.

	User Manual	Doc.Ref : JA-KNX-UM
	JA-KNX – Jablotron KNX Interface	Revision : 3.00
		Page : 18 of 18

8. DATASHEET

TECHNICAL DATA	VALUE
Power supply	External 12VDC
Power consumption KNX bus typ.	< 16 mA @ 29VDC
Operating temperature	5 to + 45°C
Enclosure	Optional DIN-rail housing
Dimensions (W x D x H)	81 x 29 x 20mm
Mounting	1 screw holes for mounting in the Jablotron control panel
KNX terminal	Pluggable micro terminal, Red/Black, 4 pole PUSH WIRE for solid conductor wire 0.6-0.8 mm ²
12VDC terminal	Screw terminal 12VDC / GND To be supplied from Jablotron panel or an external power supply
RS485 terminal	Screw terminal D+(A) / D- (B)
Configurable input/output (PG)	32
Configurable zones	4
KNX bus voltage	29 VDC
RS485 voltage	3.3 VDC